

RISO SE 9480

Specifications are subject to change without notice. Details may vary depending on the region.

- *1 When installed with RISO Auto document feeder DX-1.
- *2 When installed with RISO Auto document feeder AF-VI.II.
- *3 When installed with RISO Auto-control stacking tray.

Note: All dimensions are when installed with RZ stand D type.

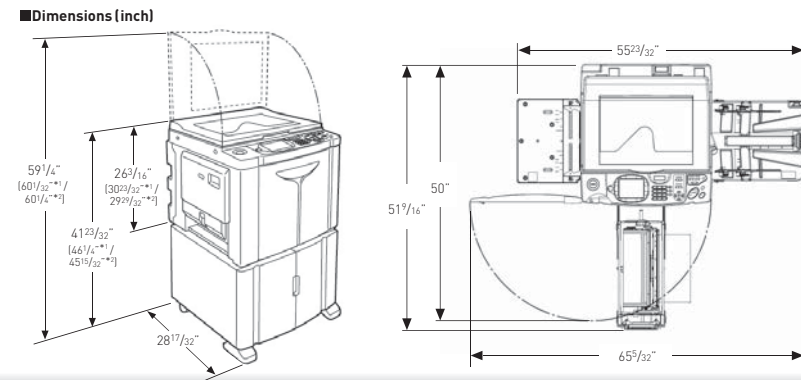

RISO SE9480 Specifications

Master-making/printing methods	High-speed digital master-making/full automatic stencil printing
Original Type	Book (22 lb (10 kg) or less), sheet
Resolution	Scanning resolution: 600 dpi × 600 dpi Printing image resolution: 600 dpi × 600 dpi
Original Size (min./max.)	When using the Glass Platen: 3 1/32" × 3 1/32" (50 mm × 90 mm) - 12 7/32" × 17" (310 mm × 432 mm) When using the Auto Document Feeder AF-VI.II (option): 3 15/16" × 5 13/16" (100 mm × 148 mm) - 12 7/32" × 17" (310 mm × 432 mm) When using the Auto Document Feeder DX-1 (option): 4 1/8" × 5 1/32" (105 mm × 128 mm) - 11 1/16" × 17" (297 mm × 432 mm)
Original Paper Weight	When using the Auto Document Feeder AF-VI.II (option): 13-lb bond (50 gsm) - 34-lb bond (128 gsm) When using the Auto Document Feeder DX-1 (option): Single-sided feeding: 11-lb bond (40 gsm) - 34-lb bond (128 gsm) Duplex-sided feeding: 14-lb bond (52 gsm) - 28-lb bond (105 gsm)
Printing Paper Size (min./max.)	3 15/16" × 5 13/16" (100 mm × 148 mm) - 12 19/32" × 17" (320 mm × 432 mm)* *Paper up to 21 7/32" (555 mm) from top to bottom may be used in the Extended Paper mode.
Paper Supply Capacity	Approx. 1,000 sheets (21-lb bond (80 gsm)) /Maximum Height 4 11/32" (110 mm)
Paper Receiving Capacity	Approx. 1,000 sheets (21-lb bond (80 gsm)) /Maximum Height 4 11/32" (110 mm)
Printing Paper Weight	12-lb bond (46 gsm) - 110-lb index (210 gsm)
Image Processing mode	Line, Photo (Standard/Portrait/Group), Duo (Line/Photo/Shadow off), Pencil (Darker/Lighter)
Master-making Time	Approx. 19 seconds (for Letter/short edge feed/100% reproduction ratio) Approx. 16 seconds (for Letter/long edge feed/100% reproduction ratio)
Printing Area (max.)	11 15/32" × 16 23/32" (291 mm × 425 mm)
Print Reproduction Ratio	Zoom: 50 - 200% Standard reproduction ratio (enlargement): 200%, 154%, 129%, 121% Standard reproduction ratio (reduction): 78%, 65%, 61%, 50% Margin+: 90 - 99 %
Print Speed	60 - 130 sheets per minute (control panel: five steps variable) 180 - 185 sheets per minute (Touch panel:"High Speed")
Print Position Adjustment	Vertical: ± 19/32" (±15 mm) Horizontal: ± 25/64" (±10 mm)
Ink Supply	Fully automatic (1,000 ml per cartridge)
Master Supply/Disposal	Fully automatic (approx. 215 sheets per roll)
Master Disposal Capacity	100 sheets
User Interface	LCD Touch Panel with Progress Arrow indicators
Optional Accessories	Auto Document Feeder AF-VI, Auto Document Feeder DX-1, Color Print Cylinder, Auto-Control Stacking Tray, Wide Stacking Tray, Key Card Counter, Job Separator, Document Storage Card DM-128CF/DM-512CF, RISO Controller IS300, Stand D type, Stand N type, RISO Printer Driver for Macintosh
Operating Noise	Max. 66 dB(A) (when printing 100 sheets per minute)
Power Source	AC 100-240 V, 50-60 Hz <5.0-2.2 A>
Power Consumption (without accessories)	Max. 400 W (100 V)/380 W (220 V) At Ready: approx. 52 W (100 V)/52 W (220 V) At Sleep: approx. 3.0 W (100 V)/4.0 W (220 V)
Functions	Idling, Print Speed Adjustment, Silent mode, Confidential mode, Auto-Process, Job Memory, Ink Saving, Layout, Binding Margin, Reservation, Output Reversal, Proof, Double Feed Check, User Management, Management of Consumables, Contrast Adjustment, Print Density Adjustment, Print Position Adjustment, Tone Curve, Jump Wing Control, Top Margin, Paper Size detection, Renew Page, Dot Process (4 types), Preview, Rotate, Scanning Side (with optional ADF DX-1), Admin. Mode, Interval Printing, Max. Scan, Special Paper Control, Auto 90° Rotation, Protect, Paper Size Selection, Overlay (with optional memory card or USB Flash Drive), Direct Print, Storage memory (with optional memory card), Scan Mode (with optional memory card or USB Flash Drive), My Direct Access, ID Counter Report, USB Job List (with USB Flash Drive), Custom Paper Entry, Programmed Printing (2 types), Direct Access Entry, Selections Entry, Book Shadow, RISO i Quality System, Scanning Contrast (Manual/Auto), Multi-Up Print (2 up/Single-Original/Multiple-Original/ Multi-Up Tickets), ADF Semi-Auto (with optional ADF unit installed), Energy Saving Mode (Auto Sleep, Auto Power-OFF), ECO Mode
Dimensions	When in use: 55 23/32" (W) × 27 3/4" (D) × 26 7/16" (H) (1,415 mm(W) × 705 mm(D) × 665 mm(H)) When in storage: 30 23/32" (W) × 27 3/4" (D) × 26 7/16" (H) (780 mm(W) × 705 mm(D) × 665 mm(H))
Required Space*1	65 7/32" (W) × 51 9/16" (D) × 59 1/4" (H) (1,655 mm (W) × 1,310 mm (D) × 1,505 mm (H))
Weight*2	Approx. 254 lb (115 kg)
Safety Standard	IEC-60950-1 compliant, Indoor, pollution degree 2*3, At altitudes of 6,500 feet or lower

Note: • Please note that due to improvements and changes to the machine, some images and explanations in this brochure may not correspond to your machine.
• The specifications are subject to change without prior notice.

*1 The height includes the height of the dedicated stand.

*2 The weight does not include Ink and Master.

*3 The pollution degree of the usage environment due to dirt and dust in the air. Degree "2" corresponds to general indoor environment.



RISO SE 9480

Increase productivity with the world's fastest digital duplicator.



RISO logo, RISO i Quality System™ and  are either registered trademarks or trademarks of RISO KAGAKU CORPORATION. Adobe and PostScript are either registered trademarks or trademarks of Adobe Systems Incorporated in the United States and/or other countries. Mac OS is a trademark of Apple, Inc. Windows is either a registered trademark or trademark of Microsoft Corporation in the United States and/or other countries.



For more details please contact:

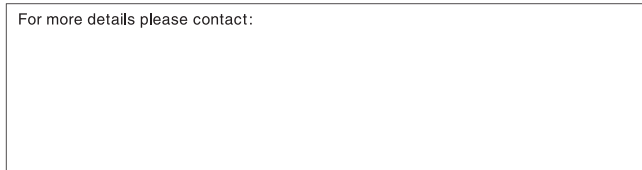

Accelerate your tasks.

Put the power of 185 ppm printing to work for you.

The RISO SE9480 digital duplicator offers exceptional print quality at an unrivalled unrivalled maximum print speed and incredibly low operating cost, enabling easy and efficient high volume printing. It reproduces photographs and text with remarkable image quality and, in addition to enhanced environmental features, incorporates a variety of improved print functions.

And the highly dependable SE series let you use various types of paper, making them more versatile than ever.



RISO SE 9480 The large-volume digital duplicator with unparalleled performance

High Productivity

Print more copies, in less time, at less cost.



Unrivalled maximum print speed of 185 pages per minute.

In addition to an adjustable five-speed function for printing between 60 and 130 pages per minute, the RISO SE9480 digital duplicator has a high-speed mode that outputs at a maximum speed of 185 pages per minute, the fastest ppm rate in the industry. Marketing and promotional materials, meeting handouts, and other high-volume documents, regardless of the required paper size, can be produced with speed and efficiency in a fraction of the time previously required for a similar job.

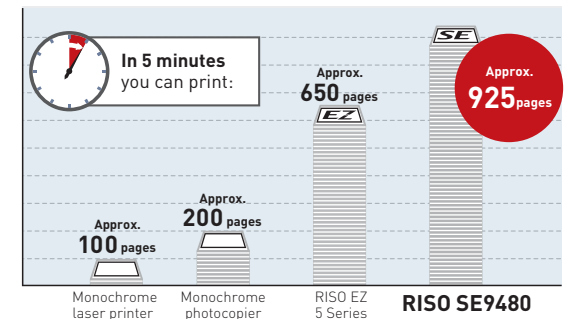

Note: Comparison of the RISO SE9480 (185 pages per minute) and RISO EZ 5 Series (130 pages per minute) digital duplicators with monochrome photocopiers (letter size, 40 pages per minute) and monochrome laser printers (letter size, 20 pages per minute).

The larger the job size, the lower the running cost.

The RISO SE9480 first creates a master copy of the original document, from which prints are made. The printing cost per copy of a document goes down with every print, making the RISO SE9480 highly economical for large-volume printing. Optional "A4/letter" cylinders can be used to print popular sizes even more efficiently to save master usage, holding down running costs to a minimum.

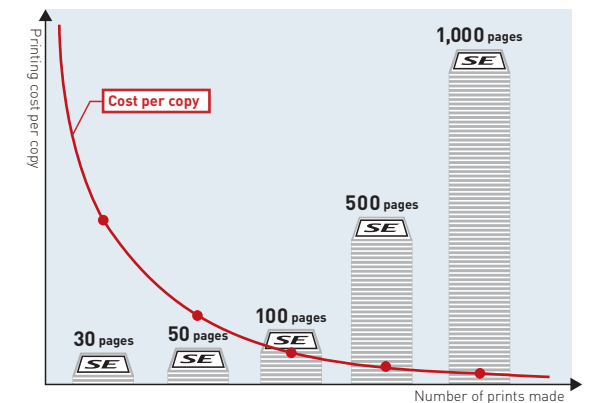

Easily separates your print jobs into specified lots.

The RISO Job Separator IV:NIII, an optional feature on the RISO SE series, enables tape to be inserted between printing jobs even during high-speed printing and speedily separates the printed paper into lots of specified numbers, all without interrupting the printing process.



Notes: The Receiving Tray Paper Guide must be changed in the RISO Job Separator IV: NIII high-speed mode. The RISO Job Separator IV:NIII high-speed mode is not available with the RISO Auto-control stacking tray.

High Quality

Sharp, rich images give your ideas impact on the page.



High-resolution 600 dpi scanning and printing produces crisp images.

The RISO SE9480 digital duplicator both scans and prints information at a high resolution level of 600 dpi, producing sharp, clear images of even fine lines and small characters. The model uses the new RISO Master E Type HG, with a two-layer ink-permeable sheet adding an extra fine-filter layer to the standard layer, enabling even ink transfer to the paper. It can also reproduce subtle color gradations, enabling users to print clear copies of photos, shaded areas of images, and documents written in pencil.

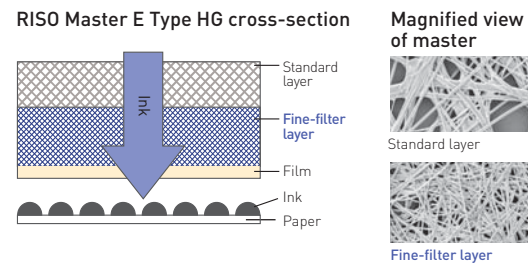

Unique technology for uniform, solid images.

The RISO SE9480 model uses an integrated pre-suction mechanism, in which air is passed between the paper and the print cylinder to draw the paper downward, separating it evenly and cleanly from the cylinder before it is output. This unique technology allows the ink to be transferred uniformly to the paper to produce clear images.

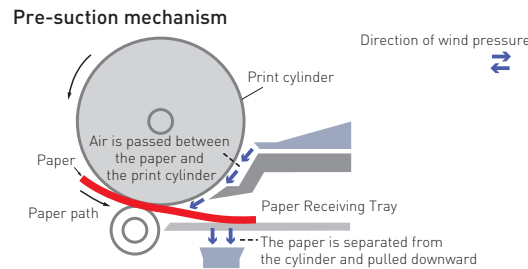

A rainbow of variety for your work.

The machine's color cylinder accommodates a wide variety of inks in a range of standard colors, as well as additional special edition and custom colors that can give corporate logos an extra-special look. This huge selection of available colors lets you add powerful impact to your documents. And because the ink is made by RISO, you're assured of the highest quality results. Front panel access makes switching the cylinder quick and easy to change color, too.

Red	Bright Red	RISO-Marine Red	Burgundy
Brown	Yellow	Green	Teal
Blue	Medium Blue	RISO-Fed. Blue	Purple
Flat Gold	Orange	Crimson	Hunter Green
Gray	Light Gray	Fluorescent Pink	Fluores. Orange
		Gold	

[Custom colors]

Note: The actual colors may differ from the samples shown above.



Multiple image quality modes optimize image quality.

Select from a number of image modes, such as Line, Photo or Pencil, best suited to the original photo or document. Choose Duo mode for documents that are a mix of text and photos, process only the photos and print out crisp images with clear text.



Photo mode: Portrait

Photo mode: Group

Pencil mode

Ease of Operation

A simple, intuitive design enhances the ease of use.



Print from hard copy, electronic file, external memory

The RISO SE9480 digital duplicator can print your documents from a variety of sources:

- Original hard copy
- Networked computer/data file
- USB flash drive
- Stored data within the unit

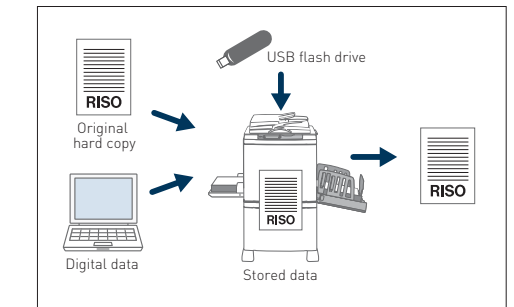

A large display for convenient editing of your document.

The large, interactive touchscreen display panel enables easy default settings and operation. The visibility of the LCD panel can be enhanced through color reversal, or by adjusting the contrast setting. The original document, whether paper or digital data, can be saved in the Storage folder, displayed on the touchscreen, and reviewed. Using the touch screen stylus the RISO Editor enables easy image processing and separation of text blocks and images for spot color printing. The information displayed can be magnified, enabling easy review of the content.

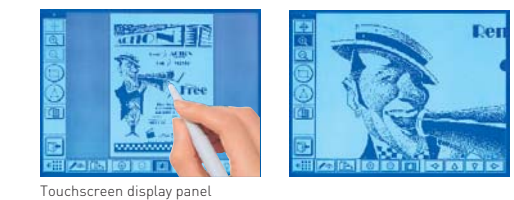

Touchscreen display panel



Save paper by consolidating information on a single page.

Multi-page documents can be consolidated into fewer pages and in an easier-to-read format with the "Multi up" layout function, reducing the amount of paper required for printing.

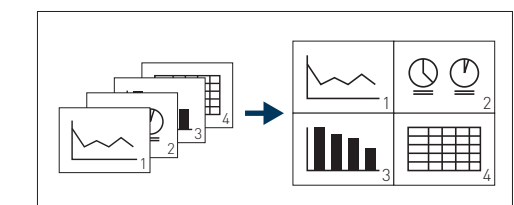

Eco-friendly

Exceptional performance,
with lower environmental impact.



RISO: eco-friendly products for a greener world.

RISO is proud to recognize its responsibility as a member of the global community. Our basic philosophy is to contribute to society through the development of excellent, energy-efficient and environmentally responsible products. We strive to contribute to global environmental protection to preserve a healthy, sound environment for future generations.



Recycled materials

Ink bottles and some parts for the SE series are made of PET5 recyclable plastic, and include material made from recycled components.



ENERGY STAR® Program

RISO machines are compliant with an international program that promotes energy saving in printing machines, and sets standards in terms of the power consumption of printing machines.



RoHS Directive

RISO machines are also compliant the world over, meeting the stringent conditions of the EU's directives on the restriction of the use of certain hazardous substances in electrical and electronic equipment.



Energy-efficient printing

The digital duplicator uses no toner, and therefore needs no heat source to affix the toner during the print process. Turn the duplicator on and it's ready to go in an instant, letting you save energy whenever it's not in use. And high-speed printing means your job is done sooner, so you can turn it off that much more quickly.



RISO Ink is made of eco-friendly soy oil

One of the ingredients of RISO INK is soy oil, making it a high-quality, eco-friendly product. It meets the soy oil content standards specified by the American Soybean Association and is certified to use the "CONTAINS SOYOIL" trademark.

Note: Order-made custom colors may not be available in soy-oil-based inks.

Environmentally-friendly functions.

The SE series comes with "Eco-mode" functions that let you adjust the control panel brightness and pressure in the press unit. Eco-mode can reduce electricity consumption by up to 2%.

Power down the unit at a fixed time with the "Auto Power-Off" function or save energy with the "Auto Sleep" function that puts the unit into a sleep mode until network activity brings it back online.



Eco-mode off



Eco-mode on

Smart, easy, and versatile: Your printing the way you want it.

Full expandability to give you the functions you need.



Auto document feeder AF-VI-II
Automatic feed of up to 50 sheets of originals.



Auto document feeder DX-1
Automatic scanning of both sides of originals and automatic feeding. 50-sheet capacity.



Card feed kit
Allows use of thicker stock such as cards and envelopes.



RISO Key card counter IV: N
Helps manage costs by showing number of copies printed and masters used in a given time period.



Job Separator IV:NIII
Allows the machine to print and sort into groups separated by tape.



RISO Auto-control stacking tray
The paper guides automatically open out to suit the paper size.



Envelope feeder
Compatible with paper weight 50 gsm to 120 gsm.
*Please contact a RISO sales executive for the kinds of envelope that may be used.



RISO controller IS300
Provides compatibility with Adobe® PostScript®3™.



Color cylinder
A wide variety of colors is available. Cylinders can be stored in their own cases.

Wide stacking tray
Allows use of paper up to 555mm from top to bottom.

Document storage card DM-128CF/DM-512CF
Allows storage of frequently used documents for instant recall.

RISO Printer driver for Macintosh
Printer driver on CD for Mac OS.

A complete range of RISO SE Series supplies.



RISO Ink

You can choose from a range of standard colors, as well as additional special edition and custom colors—ideal for applications such as specific corporate colors.

Ink
RISO INK ETYPE HD BLACK
RISO INK ETYPE COLOR

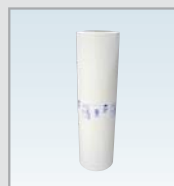

RISO Master

High-quality RISO masters provide the best performance match with SE series printers, giving a sharp, clear image to all your documents.

Master
RISO MASTER ETYPE HG 97
RISO MASTER ETYPE HD 87

RISO iQualitySystem™

The RISO iQuality System™ offers a large number of quality and convenience benefits.

Among them are:

- Automatic assurance of optimum print quality.
- Prevention of operator error.
- Warning of shortages in remaining ink/master volume.
- Minimized paper waste.



The RISO iQuality mark indicates a RISO product compatible with the RISO iQuality System.